

# ESKRIDGE

## 252L PLANETARY GEAR DRIVE SERVICE AND REPAIR MANUAL

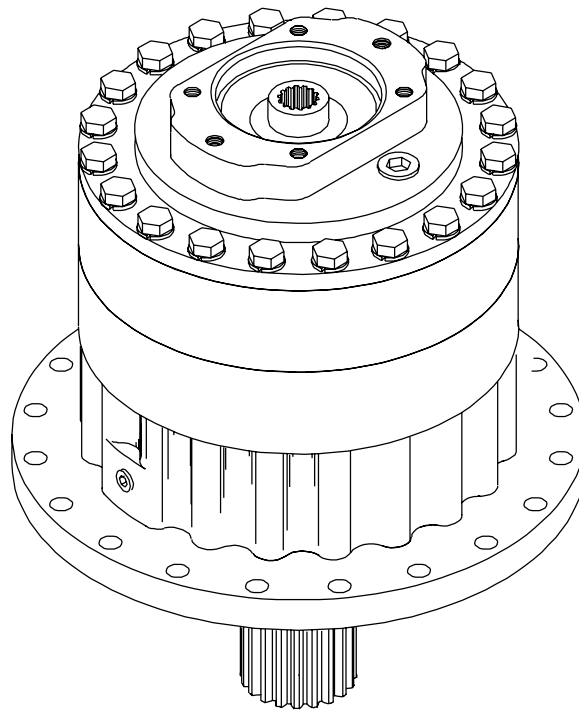

### Example Part Number

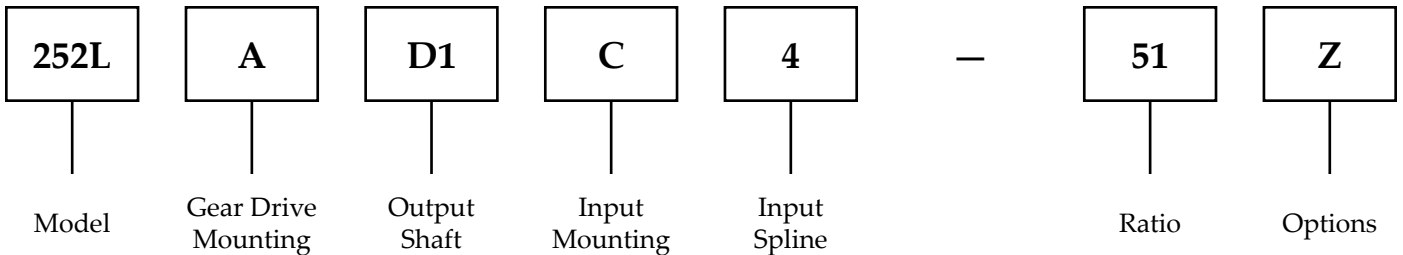

THIS SERVICE MANUAL IS EFFECTIVE  
FROM: ..... S/N 28500, JAN. 1997  
TO: ..... CURRENT  
REF: ..... SM252LD2-AB

# 252L MODEL SERVICE MANUAL

## DOUBLE STAGE PLANETARY GEAR DRIVE

This manual will assist in disassembly and assembly of the above model planetary geardrives. Item numbers, indicated in parentheses throughout this manual, refer to the exploded parts breakdown drawing. Individual customer specifications (mounting case, output shaft, brake assembly, etc.) may vary from exploded drawing and standard part numbers shown. If applicable, refer to individual customer drawing for details.

For any spare or replacement parts, contact your distributor or equipment manufacturer. Always try to have available the geardrive unit part number, serial number and date code on the serial tag. This information may be necessary for verification of any component part numbers. Component part numbers and/or manufacturing lot numbers may be stamped on individual parts. This information may also be helpful in identifying replacement components.

## LUBRICATION & MAINTENANCE

**Change the oil after the first 50 hours of operation.** Oil should be changed at 500 hour intervals thereafter. Use a GL-5 grade EP 80/90 gear oil (EP = "Extreme Pressure"). The geardrive should be partially disassembled to inspect gears and bearings at 1000 hour intervals.

If your unit was specified "shaft up" or with a "-Z" option, a grease zerk was provided in the base housing. For shaft-up operation, the output bearing will not run in oil and must be grease lubricated. Use a lithium base or general purpose bearing grease sparingly every 50 operating hours or at regular maintenance intervals. Over-greasing the output bearing tends to fill the housing with grease and thicken the oil.

### Operating Position

Horizontal Shaft

Vertical Shaft

### Oil Capacity

6.75 pints / 3.2liters

12.75 pints / 6.0 liters

### Oil Level

To horizontal centerline of gear drive

To midway on upper/primary gear set



**WARNING: While working on this equipment, use safe lifting procedures, wear adequate clothing and wear hearing, eye and respiratory protection.**

## CONTENTS

|  |          |
|--|----------|
| <b>Example Part Number .....</b>                                 | <b>1</b> |
| <b>Lubrication &amp; Maintenance.....</b>                        | <b>2</b> |
| <b>Unit Disassembly Procedure.....</b>                           | <b>3</b> |
| <b>Primary Planet Carrier Subassembly .....</b>                  | <b>3</b> |
| <b>Secondary Planet Carrier Subassembly .....</b>                | <b>3</b> |
| <b>Base Subassembly .....</b>                                    | <b>4</b> |
| <b>Unit Reassembly .....</b>                                     | <b>4</b> |
| <b>252L Double Stage Exploded View Drawing.....</b>              | <b>6</b> |
| <b>Eskridge Product Warranty .....</b>                           | <b>7</b> |
| <b>Warranty Return Policy.....</b>                               | <b>7</b> |
| <b>Other Eskridge Products .....</b>                             | <b>8</b> |
| <b>Planetary Gear Drives .....</b>                               | <b>8</b> |
| <b>Multiple Disc Brakes .....</b>                                | <b>8</b> |
| <b>Planetary Auger Drives, Anchor Drives &amp; Diggers .....</b> | <b>8</b> |

# Unit Disassembly Procedure

(Refer to exploded view drawing)

- 1) Scribe a diagonal line across the outside of the unit from the cover (4) to the base (1) before disassembly to assure proper positioning of pieces during reassembly.
- 2) Remove magnetic drain plug (33) and drain oil from unit. Maximum drainage occurs when oil is warm.
- 3) Remove the twenty hex head capscrews (29) and lockwashers (32).
- 4) Remove the cover (4), thrust washer (28), input gear (11), and carrier thrust washer (14). Inspect o-ring (15); discard if damaged or if it has taken a set.
- 5) Lift the primary planet carrier assembly out of the unit (includes Items 5, 10, 13, 16, 25, & 30).
- 6) If sun gear (9) has not been removed from gearbox, do so now. (Sometimes the sun gear remains in the primary carrier (5).)
- 7) Remove primary ring gear (2). Inspect second o-ring (15), as before; discard if damaged.
- 8) Remove carrier thrust washer (14). Lift the secondary planetary assembly out of the unit (includes Items 6, 8, 12, 17, 23, 24, & 31). Use a puller if necessary.
- 9) Remove secondary ring gear (3). Inspect third o-ring (15), as before; discard if damaged.
- 10) The unit is now disassembled into groups of parts. The area(s) requiring repair should be identified by thorough inspection of the parts after they have been cleaned and dried.

## Primary Planet Carrier Subassembly

(Items 5, 10, 13, 16, 25, & 30)

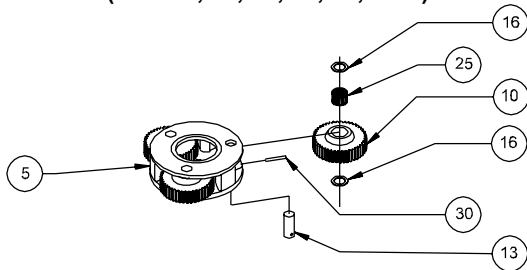

Rotate planet gears (10) to check for abnormal noise or roughness in bearings (25) or planet shafts (13). If further inspection or replacement is required, proceed as follows.

**NOTE: Support carrier (5) only while pressing out planet shafts.**

- 1) Drive roll pins (30) completely into the planet shafts (13).
- 2) Press or drive planet shafts (13) out of carrier (5).
- 3) Remove planet gears (10) and planet washers (16) from the carrier (5).
- 4) If the planet bearings (25) require replacement, press them out of the planet gears (10) and replace with new ones.
- 5) Check primary planet shafts (13) for any abnormal wear, especially ones where bearings needed to be replaced. If any abnormal wear is found, replace planet shafts.
- 6) Use 3/16 inch pin punch to remove roll pins (30) from planet

shafts (13).

## Reassembly

- 1) With planet washers (16) on both sides of the planet gear (10) and with bearings (25) installed, slide gear into the carrier (5). Insert the planet shaft (13) through the carrier, washers, and planet gear.
- 2) Planet shafts (13) should be installed with chamfered end of 3/16 inch hole toward outside diameter of the carrier (5). This will aid in alignment of holes while inserting roll pins (30).
- 3) Drive a roll pin (30) through the carrier hole and into the planet shaft to retain the parts. Repeat for other planet gears.

## Secondary Planet Carrier Subassembly

(Items 6, 8, 12, 17, 23, 24, & 31)

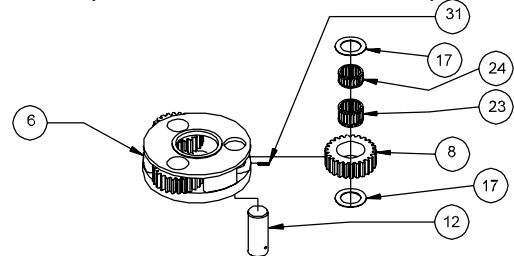

Follow the same procedure as that for the primary planetary assembly. Substitute Items as indicated: planet gears (8), planet bearings (23 & 24), planet shafts (12), roll pins (31), carrier (6) and washers (17).

Rotate planet gears (8) to check for abnormal noise or roughness in bearings (23 & 24) or planet shafts (12). If further inspection or replacement is required, proceed as follows.

**NOTE: Support carrier (6) only while pressing out planet shafts.**

- 1) Drive roll pins (31) completely into the planet shafts (12).
- 2) Press or drive planet shafts (12) out of carrier (6).
- 3) Remove planet gears (8) and planet washers (17) from the carrier (6).
- 4) If the planet bearings (23 & 24) require replacement, press them out of the planet gears (8) and replace with new ones.
- 5) Check primary planet shafts (12) for any abnormal wear, especially ones where bearings needed to be replaced. If any abnormal wear is found, replace planet shafts.
- 6) Use 3/16 inch pin punch to remove roll pins (31) from planet shafts (12).

## Reassembly

- 1) With planet washers (17) on both sides of the planet gear (8) and with bearings (23 & 24) installed, slide gear into the carrier (6). Insert the planet shaft (12) through the carrier, washers, and planet gear.
- 2) Planet shafts (12) should be installed with chamfered end of 3/16 inch hole toward outside diameter of the carrier (6). This will aid in alignment of holes while inserting roll pins (31).
- 3) Drive a roll pin (31) through the carrier hole and into the planet shaft to retain the parts. Repeat for other planet gears.

## Base Subassembly

(Items 1, 7, 18, 19, 20, 21, 22, 26, 27, 33, 35, & 36)

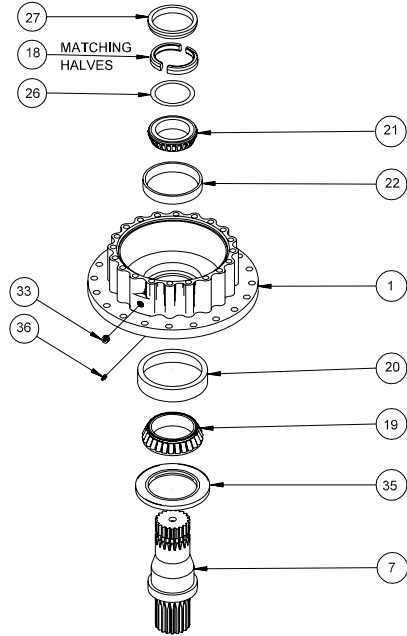

- 1) Remove the lock ring (27) using a heel bar or puller. If using a heel bar, do not pry against the cage of the inner output shaft bearing (21). Remove the split ring segments (18) and shims (26).

**CAUTION: Output shaft is no longer retained. Care should be taken not to injure feet because output shaft can fall out. Care should also be taken not to damage output shaft when shaft is pressed through base.**

- 2) Output shaft removal. Base (1) should be set pinion side down, as shown, on a plate or table with output shaft (7) protruding through a hole in table. Press output shaft out bottom of base by applying a load to top end (**internal end**) of shaft until it passes through inner shaft bearing cone (21).
- 3) If outer bearing cone (19) (**on the shaft**) needs to be removed a gear puller may be used, otherwise skip to step number 6. If reusing old bearing cone, do not pull on or damage roller cage. Remove the shaft seal (35) for inspection or replacement.
- 4) Lubricate inner lip of new shaft seal (35) and slide the seal onto the shaft (7) until it fits snugly over shaft seal diameter with the open side toward the inside of the gearbox.

**NOTE: Press bearing cone onto output shaft by pressing on inner race only. DO NOT press on roller cage or it may damage bearing.**

- 5) Press outer bearing cone (19) (**large end down as shown**) onto the shaft until it seats against the shoulder. Bearing cone (19) may be reused if it was removed only to replace the seal (35).
- 6) Inspect inner and outer bearing cups (20 & 22) and replace if necessary.

### Reassembly

- 1) Clean all foreign material from magnetic oil plug (33) located on side of base (1). Add a small amount of pipe thread compound to pipe plug before installing back into base.

- 2) Place the base (1) (**output side up, opposite shown**) on the press table.
- 3) Apply a layer of lithium or general purpose bearing grease to surface of outer bearing cup (20). Insert the shaft into the base (**bearing cone down**) and use a soft hammer to install the shaft seal (35) into the mounting base.

**CAUTION: Output shaft is not retained at this point.**

- 4) Invert this assembly so it is standing on the shaft (**on the press table**).

**NOTE: Press bearing cone onto output shaft by pressing on inner race only. DO NOT press on roller cage or it may damage bearing.**

- 5) Apply a layer of lithium or general purpose bearing grease to surface of inner bearing cup (22). Press the inner bearing cone (21) (**large end up as shown**) onto the shaft (7) until it is just seated against inner bearing cup (22). A slight preload of less than 100 in-lbs rolling torque should be obtained.
- 6) Relieve the press and slide the shim(s) (26) onto the shaft. Coat the split ring (18) with anti-seize compound and begin installing ring in groove of shaft. Tap the segments into the groove of the shaft until you can drive the lock ring (27) over the segments. Be sure the lock ring (27) 'clicks' over the detent which helps keep the LOAD-n-LOCK® in place. Measure the rolling torque of the output shaft; torque is the product of the force (lbs) times the distance from the center line of the gearbox (in). The rolling torque should be **50 to 100 lbs**. If the rolling torque is too high, remove the load and lock and remove a shim and install LOAD-n-LOCK® and measure again. If torque is too low, add a shim and measure again.

## Unit Reassembly

(Refer to exploded drawing)

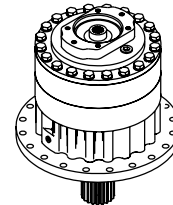

- 1) When all subassemblies are complete, unit is ready to be assembled.
- 2) Lubricate o-ring (15) and install on the O.D. pilot of the secondary ring gear (3). Referring to scribe marks for proper orientation, install the secondary ring gear (3) onto the base (1).
- 3) Install the secondary planet carrier (6); assemble by rotating it until planet gears line up with ring gear teeth and shaft spline. Press until fully seated on shaft (7).
- 4) Lubricate o-ring (15) and install on the O.D. pilot of the primary ring gear (2) and install the primary ring gear (2). Refer to scribe marks for proper orientation.
- 5) Slide the sun gear (9) into the secondary planet carrier (6).
- 6) Install carrier thrust washer (14).
- 7) Install primary planet carrier (5); assemble by rotating it until planet gears line up with ring gear teeth and sun gear spline. Assembly should drop into place.

- 8) Slide the input gear **(11)** into the primary planetary carrier.
- 9) Install carrier thrust washer **(14)** and input gear thrust washer **(28)**.
- 10) Lubricate o-ring **(15)** and install on the O.D. pilot of the cover **(4)**. Position the cover **(4)** with the proper orientation. Install the twenty 5/8-11 capscrews **(29)** with lockwashers **(32)** and torque to 220 ft-lbs (dry), 170 ft-lbs (lubed).
- 11) Fill to proper level, as specified on page 2, with EP 80/90 gear oil after unit is sealed with a brake and/or motor.

**The gearbox is now ready to use.**

# 252L Double Stage Exploded View Drawing



## MODEL 252L

EQUIPPED WITH PATENTED "LOAD-N-LOCK"®  
SHAFT RETENTION SYSTEM. (U.S. PATENT NO. 5746517).

| ITEM  | QTY | DESCRIPTION                           | RATIO →                         |                               |                               |                             |                                 |                               |
|---|-----|---------------------------------------|---------------------------------|-------------------------------|-------------------------------|-----------------------------|---------------------------------|-------------------------------|
|   |     |                                       | 20.25:1<br>4.3125:1<br>4.6957:1 | 25.88:1<br>4.3125:1<br>6.00:1 | 29.58:1<br>6.30:1<br>4.6957:1 | 37.80:1<br>6.30:1<br>6.00:1 | 40.25:1<br>8.5714:1<br>4.6957:1 | 51.43:1<br>8.5714:1<br>6.00:1 |
| EFFECTIVE:<br>FROM: S/N 28500 01/01/97<br>TO: CURRENT |     |                                       | PART NO.                        | PART NO.                      | PART NO.                      | PART NO.                    | PART NO.                        | PART NO.                      |
| 1   | 1   | 250A BASE - ROUND                     | 25-004-3012                     | 25-004-3012                   | 25-004-3012                   | 25-004-3012                 | 25-004-3012                     | 25-004-3012                   |
|   |     | 250F BASE - FLANGELESS                | 25-004-3022                     | 25-004-3022                   | 25-004-3022                   | 25-004-3022                 | 25-004-3022                     | 25-004-3022                   |
|   |     | CUSTOM BASE                           | -                               | -                             | -                             | -                           | -                               | -                             |
| 2   | 1   | RING GEAR - PRIMARY                   | 25-004-1012                     | 25-004-1012                   | 25-004-1012                   | 25-004-1012                 | 25-004-1012                     | 25-004-1012                   |
| 3   | 1   | RING GEAR - SECONDARY                 | 25-004-1022                     | 25-004-1022                   | 25-004-1022                   | 25-004-1022                 | 25-004-1022                     | 25-004-1022                   |
| 4   | 1   | A - SAE 'A' COVER                     | 25-005-2061                     | 25-005-2061                   | 25-005-2061                   | 25-005-2061                 | 25-005-2061                     | 25-005-2061                   |
|   |     | B - SAE 'B' COVER                     | 25-005-2051                     | 25-005-2051                   | 25-005-2051                   | 25-005-2051                 | 25-005-2051                     | 25-005-2051                   |
|   |     | C - SAE 'C' (2 AND 4 BOLT)            | 25-004-1222                     | 25-004-1222                   | 25-004-1222                   | 25-004-1222                 | 25-004-1222                     | 25-004-1222                   |
|   |     | D - SAE 'D' COVER                     | 25-004-1232                     | 25-004-1232                   | 25-004-1232                   | 25-004-1232                 | 25-004-1232                     | 25-004-1232                   |
| 5   | 1   | CARRIER - PRIMARY                     | 25-004-1052                     | 25-004-1052                   | 25-004-1042                   | 25-004-1042                 | 25-004-1032                     | 25-004-1032                   |
| 6   | 1   | CARRIER - SECONDARY                   | 25-004-1072                     | 25-004-1062                   | 25-004-1072                   | 25-004-1062                 | 25-004-1072                     | 25-004-1062                   |
| 7   | 1   | D1 - OUTPUT SHAFT 20T 6/12 SPLINE     | 25-004-4012L                    | 25-004-4012L                  | 25-004-4012L                  | 25-004-4012L                | 25-004-4012L                    | 25-004-4012L                  |
|   |     | D2 - OUTPUT SHAFT 3.75" DIA, KEYED    | 25-004-4022L                    | 25-004-4022L                  | 25-004-4022L                  | 25-004-4022L                | 25-004-4022L                    | 25-004-4022L                  |
|   |     | S1 - SPINDLE SHAFT                    | 25-004-4052L                    | 25-004-4052L                  | 25-004-4052L                  | 25-004-4052L                | 25-004-4052L                    | 25-004-4052L                  |
|   |     | C1 - OUTPUT SHAFT - CUSTOM            | -                               | -                             | -                             | -                           | -                               | -                             |
| 8   | 3   | PLANET GEAR - SECONDARY               | 25-004-1092                     | 25-004-1082                   | 25-004-1092                   | 25-004-1082                 | 25-004-1092                     | 25-004-1082                   |
| 9   | 1   | SUN GEAR - SECONDARY                  | 25-004-1152                     | 25-004-1142                   | 25-004-1152                   | 25-004-1142                 | 25-004-1152                     | 25-004-1142                   |
| 10  | 3   | PLANET GEAR - PRIMARY                 | 25-004-1122                     | 25-004-1122                   | 25-004-1112                   | 25-004-1112                 | 25-004-1102                     | 25-004-1102                   |
| 11  | 1   | INPUT GEAR INPUT 14T SPL              | 25-004-1202                     | 25-004-1202                   | 25-004-1172                   | 25-004-1172                 | 25-004-1162                     | 25-004-1162                   |
|   |     | INPUT GEAR INPUT 13T SPL              | 25-004-1292                     | 25-004-1292                   | 25-004-1282                   | 25-004-1282                 | 25-004-1272                     | 25-004-1272                   |
| 12  | 3   | PLANET SHAFT - SECONDARY              | 25-004-1021                     | 25-004-1021                   | 25-004-1021                   | 25-004-1021                 | 25-004-1021                     | 25-004-1021                   |
| 13  | 3   | PLANET SHAFT - PRIMARY                | 25-004-1031                     | 25-004-1031                   | 25-004-1031                   | 25-004-1031                 | 25-004-1031                     | 25-004-1031                   |
| 14  | 2   | THRUST WASHER - CARRIER               | 25-004-1132                     | 25-004-1132                   | 25-004-1132                   | 25-004-1132                 | 25-004-1132                     | 25-004-1132                   |
| 15  | 3   | SEAL (O-RING)                         | 01-402-0020                     | 01-402-0020                   | 01-402-0020                   | 01-402-0020                 | 01-402-0020                     | 01-402-0020                   |
| 16  | 6   | THRUST WASHER - PRI. PLANET           | 81-004-1561                     | 81-004-1561                   | 81-004-1561                   | 81-004-1561                 | 81-004-1561                     | 81-004-1561                   |
| 17  | 6   | THRUST WASHER - SEC. PLANET           | 25-004-1041                     | 25-004-1041                   | 25-004-1041                   | 25-004-1041                 | 25-004-1041                     | 25-004-1041                   |
| 18  | 1   | SPLIT RING - LOAD-N-LOCK              | 25-004-1182                     | 25-004-1182                   | 25-004-1182                   | 25-004-1182                 | 25-004-1182                     | 25-004-1182                   |
| 19  | 1   | BEARING CONE - OUTER                  | 01-102-0240                     | 01-102-0240                   | 01-102-0240                   | 01-102-0240                 | 01-102-0240                     | 01-102-0240                   |
| 20  | 1   | BEARING CUP - OUTER                   | 01-103-0240                     | 01-103-0240                   | 01-103-0240                   | 01-103-0240                 | 01-103-0240                     | 01-103-0240                   |
| 21  | 1   | BEARING CONE - INNER                  | 01-102-0250                     | 01-102-0250                   | 01-102-0250                   | 01-102-0250                 | 01-102-0250                     | 01-102-0250                   |
| 22  | 1   | BEARING CUP - INNER                   | 01-103-0250                     | 01-103-0250                   | 01-103-0250                   | 01-103-0250                 | 01-103-0250                     | 01-103-0250                   |
| 23  | 3   | BEARING - SEC PLANET GEAR             | 01-105-0550                     | 01-105-0550                   | 01-105-0550                   | 01-105-0550                 | 01-105-0550                     | 01-105-0550                   |
| 24  | 3   | BEARING - SEC PLANET GEAR             | 01-105-0560                     | 01-105-0560                   | 01-105-0560                   | 01-105-0560                 | 01-105-0560                     | 01-105-0560                   |
| 25  | 3   | BEARING - PRI PLANET GEAR             | 01-105-0570                     | 01-105-0570                   | 01-105-0570                   | 01-105-0570                 | 01-105-0570                     | 01-105-0570                   |
| 26  | *   | SHIM - SHAFT ADJUSTMENT               | 25-004-1051                     | 25-004-1051                   | 25-004-1051                   | 25-004-1051                 | 25-004-1051                     | 25-004-1051                   |
| 27  | 1   | LOCK RING - LOAD-N-LOCK               | 25-004-1192                     | 25-004-1192                   | 25-004-1192                   | 25-004-1192                 | 25-004-1192                     | 25-004-1192                   |
| 28  | 1   | THRUST WASHER - INPUT GEAR            | 81-004-2883                     | 81-004-2883                   | 81-004-2883                   | 81-004-2883                 | 81-004-2883                     | 81-004-2883                   |
|   |     | THRUST WASHER - F/U/W/ 13T 8/16 INPUT | 01-112-0030                     | 01-112-0030                   | 01-112-0030                   | 01-112-0030                 | 01-112-0030                     | 01-112-0030                   |
| 29  | 20  | HEX HEAD CAPSCREW (5/8-11 X 7) GR 8   | 01-150-1630                     | 01-150-1630                   | 01-150-1630                   | 01-150-1630                 | 01-150-1630                     | 01-150-1630                   |
| 30  | 3   | ROLL PIN (3/16 X 1)                   | 01-153-0020                     | 01-153-0020                   | 01-153-0020                   | 01-153-0020                 | 01-153-0020                     | 01-153-0020                   |
| 31  | 3   | ROLL PIN (3/16 X 1 1/4)               | 01-153-0190                     | 01-153-0190                   | 01-153-0190                   | 01-153-0190                 | 01-153-0190                     | 01-153-0190                   |
| 32  | 20  | LOCKWASHER - (5/8)                    | 01-166-0040                     | 01-166-0040                   | 01-166-0040                   | 01-166-0040                 | 01-166-0040                     | 01-166-0040                   |
| 33  | 1   | PIPE PLUG (1/2 NPT MAGNETIC) - BASE   | 01-207-0041                     | 01-207-0041                   | 01-207-0041                   | 01-207-0041                 | 01-207-0041                     | 01-207-0041                   |
| 34  | 1   | PLUG - COVER                          | 01-208-0030                     | 01-208-0030                   | 01-208-0030                   | 01-208-0030                 | 01-208-0030                     | 01-208-0030                   |
| 35  | 1   | SHAFT SEAL                            | 01-405-0670                     | 01-405-0670                   | 01-405-0670                   | 01-405-0670                 | 01-405-0670                     | 01-405-0670                   |
| 36  | 1   | PLUG 1/4 NPT                          | 01-207-0020                     | 01-207-0020                   | 01-207-0020                   | 01-207-0020                 | 01-207-0020                     | 01-207-0020                   |
|   |     | GREASE FITTING (OPTIONAL-SHOWN)       | 01-215-0040                     | 01-215-0040                   | 01-215-0040                   | 01-215-0040                 | 01-215-0040                     | 01-215-0040                   |

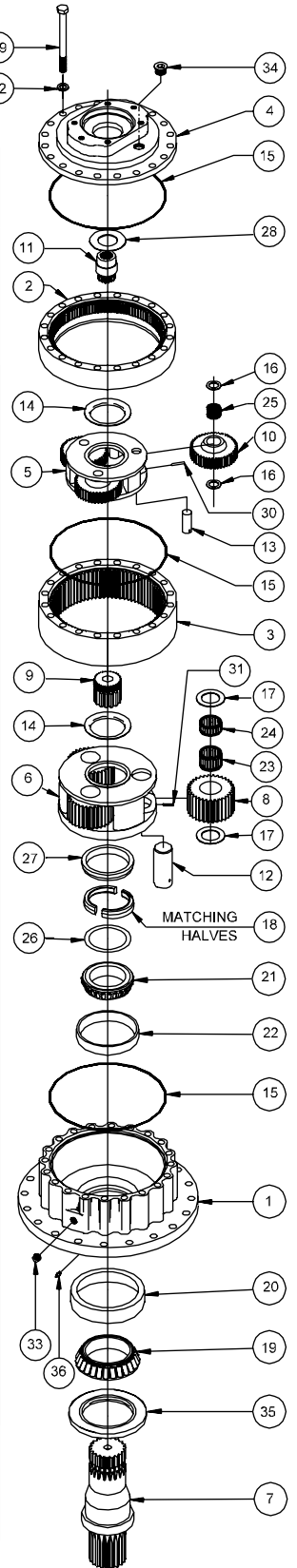

▶ FOR 13T, 8/16 INPUT SPLINE, USE P/N 01-112-0030 THRUST WASHER. (USE ONLY WITH 'D' COVER).

\* QUANTITY OF SHIMS DETERMINED BY BEARING PRELOAD.  
 OPTIONS SEAL KIT P/N 25-016-2011  
 INCLUDES 1 EA. OF ITEMS 35  
 AND A QTY 3 OF ITEM 15

E.C.N. 1803  
 X252LD2-AB DATE: 4-24-00

# Eskridge Product Warranty

ESKRIDGE, INC. ("Eskridge") warrants to its original purchaser ("Customer") that new component parts/units ("Units") sold by Eskridge will be free of defects in material and workmanship and will conform to standard specifications set forth in Eskridge sales literature current at the time of sale or to any custom specifications acknowledged by written Customer approval of drawings, SUBJECT TO THE FOLLOWING QUALIFICATIONS AND LIMITATIONS:

1. Prior to placing Units in service, the Customer shall provide proper storage such that foreign objects (e.g., rain or debris) cannot enter any Units via entry ports which are normally closed during operation.
2. The Customer must notify Eskridge in writing of any claim for breach of this warranty promptly after discovery of a defect. The warranty period shall commence when a unit is placed in service and shall expire upon the earlier of
  - a. the expiration of twelve (12) months from the date of Commencement of Service (as defined in Paragraph 4)
  - b. the completion of one thousand (1000) hours of service of the Units
  - c. the expiration of six (6) months after the expiration of any express warranty relating to the first item of machinery or equipment in which the Units are installed or on which it is mounted, or
  - d. the installation or mounting of the Units in or on an item of machinery or equipment other than the first such item in which the Units are installed or on which the Units are mounted.
3. Units shall be deemed to have been placed in service (the "Commencement of Service") at the time the machinery or equipment manufactured or assembled by the Customer and in which the Units are installed or on which the Units are mounted is delivered to the Customer's dealer or the original end-user, which ever receives such machinery or equipment first.
4. This warranty shall not apply with respect to Units which, upon inspection by Eskridge, show signs of disassembly, rework, modifications, lack of lubrication or improper installation, mounting, use or maintenance.
5. Eskridge makes no warranty in respect to hydraulic motors mounted on any Units. Failure of any such motor will be referred to the motor manufacturer.
6. Claims under this warranty will be satisfied only by repair of any defect(s) or, if repair is determined by Eskridge in its sole, absolute and uncontrolled discretion to be impossible or impractical, by replacement of the Units or any defective component thereof. No cash payment or credit will be made for defective materials, workmanship, labor or travel. IN NO EVENT SHALL ESKRIDGE BE LIABLE FOR INCIDENTAL OR CONSEQUENTIAL DAMAGES OF ANY KIND OR NATURE, FOR WHICH DAMAGES ARE HEREBY EXPRESSLY DISCLAIMED.
7. From time to time, Eskridge may make design changes in the component Units manufactured by it without incorporating such changes in the component Units previously shipped. Such design changes shall not constitute an admission by Eskridge of any defects or problems in the design of previously manufactured component Units.
8. All freight charges on Units returned for warranty service are the responsibility of the Customer.

## Warranty Return Policy

1. Any part/Unit(s) returned to Eskridge must be authorized by Eskridge with an assigned return (CSR) number.
2. All Units shall be returned freight prepaid.
3. Any Units qualifying for warranty will be repaired with new parts free of charge (except for freight charges to Eskridge as provided above).
4. If Units are found to be operable, you have two options:
  - a. The Units can be returned to you with a service charge for inspection, cleaning, and routine replacement of all rubber components and any other Units that show wear;
  - b. We can dispose of the Unit(s) at the factory if you do not wish it to be returned.

**NOTE:** Any order of Units by customer shall only be accepted by Eskridge subject to the terms stated herein. Any purchase order forms used by Customer (to accept this offer to sell) which contain terms contrary to, different from, or in addition to the terms herein shall be without effect, and such terms shall constitute material alteration of the offer contained herein under K.S.A 84-2-207 (2)(b), and shall not become part of the contract regarding the sale of the Units.

The foregoing warranty is the sole warranty made by Eskridge with respect to any Units and is in lieu of any and all other warranties, expressed or implied. There are no warranties which extend beyond the description on the face hereof without limiting the generality of the foregoing, Eskridge expressly disclaims any implied warranty of merchantability or fitness for any particular purpose, regardless of any knowledge Eskridge may have of any particular use or application intended by the purchaser. The suitability or fitness of the Units for the customer's intended use, application or purpose and the proper method of installation or mounting must be determined by the customer.

## OTHER ESKRIDGE PRODUCTS

---

### Planetary Gear Drives

| <u>SERIES</u> | <u>MODELS</u>                  | <u>TORQUE RATING (IN-LB)</u><br><b>MAX. INTERMITTENT</b> |
|---------------|--------------------------------|--|
| 20            | 20B, 20P, 20LB, 20LP           | 20,000   |
| 28            | 28B, 28P, 28M, 28LB, 28LP      | 50,000   |
| 50            | 50K/L, 50LG, 50N               | 50,000   |
| 65            | 60B, 60E, 60L                  | 60,000   |
| 100           | 100E                           | 100,000  |
| 105           | 105E                           | 100,000  |
| 130           | 130                            | 130,000  |
| 150           | 150                            | 150,000  |
| 250           | 250K/L, 251K/L, 252K/L, 253K/L | 250,000  |
| 600           | 600K/L                         | 600,000  |
| 1000          | 100K/L                         | 1,000,000  |

### Multiple Disc Brakes

| <u>SERIES</u> | <u>FEATURES</u>          | <u>TORQUE RATING (IN-LB)</u> |
|---------------|--------------------------|------------------------------|
| 90B           | SAE B                    | TO 4,800                     |
| 90BA          | SAE B, ADJUSTABLE TORQUE | TO 4,800                     |
| 92B           | SAE B, LOW PROFILE       | TO 2,800                     |
| 93            | FOR NICHOLS MOTORS       | TO 6,100                     |
| 95C           | SAE C                    | TO 12,000                    |
| 95W           | SAE C WHEEL MOUNT        | TO 21,000                    |
| 98D           | SAE D                    | TO 25,000                    |

### Planetary Auger Drives, Anchor Drives & Diggers

| <u>SERIES</u> | <u>MODELS</u>     | <u>TORQUE RATING (FT-LB)</u> |
|---------------|-------------------|------------------------------|
| D50           | 1500, 2500 & 5000 | 1,500 - 5,000                |
| 76            | BA & BC, 2-SPEED  | 8,000 - 12,500               |
| 77            | BA, BC & BD       | 6,000 - 12,500               |
| 78            | 35 & 48, 2-SPEED  | 9,000 - 12,500               |
| 75            | 38 & 51, 2-SPEED  | 16,500 - 20,000              |
| D600          | D600              | 50,000                       |
| D1000         | D1000             | 83,000                       |

